



**MAGAZINE  
FED  
SHOTGUN  
USER MANUAL**

**V.01**

---

## FIREARM OWNER'S RECORD

MODEL: WINMARK - SERIAL# \_\_\_\_\_ DATE \_\_\_\_\_ PURCHASED, \_\_\_\_ \_

**IMPORTANT WARNING .... INFORMATION AND SPECIFICATIONS CONTAINED  
IN THIS MANUAL MAY CHANGE WITHOUT NOTIFICATION**

### CARE AND MAINTENANCE OF YOUR ARMELEGANT SHOTGUN

#### 1) NEVER ALTER OR MODIFY YOUR SHOTGUN

This shotgun was produced under specific manufacturer guidelines and should not be changed under **ANY** circumstances. Altering the trigger, mechanical components, safety mechanisms, or using any other products other those provided in the original box is **NOT RECOMMENDED** by the manufacturer, and could result death, bodily harm, or compromising your safety or the safety of others. Any alteration made to the firearm also voids the factory warranty.

#### 2) PROPER CARE AND MAINTENANCE

It is essential that regular maintenance and cleaning be performed to maintain the accuracy, function, and maximize the longevity of your firearm. Before cleaning **ALWAYS** perform a safety check to make sure that the firearm is unloaded prior to cleaning.

---

## CONGRATULATIONS!!!!!!

You are now the owner of the WINMARK shotgun. Your shotgun has an innovative design and is manufactured from high quality materials. With regularly performed maintenance and the use of proper ammunition it will provide you with many years of service.

In order to achieve the best performance and reliability from your shotgun, please read and fully understand all of the instructions, safety guidelines, and warnings carefully in this manual. Your quality shotgun is enormously reliable and safe unless it is handled in a careless or irresponsible manner. **REMEMBER.... IT IS IMPERATIVE THAT THE FIREARM HANDLER BE FULLY EDUCATED AND CONSCIOUS OF THE IMPORTANCE OF EXECUTING PROPER GUN SAFETY RULES WHEN OPERATING ANY FIREARM.**

Before using or firing with any live ammunition you should know and fully understand your shotgun's parts, function, and operating mechanisms. So carefully read and fully understand all of the information about the parts and procedures of using the shotgun safely and effectively.

## A GUN OWNER'S RESPONSIBILITY

As the owner of a firearm you have the responsibility and obligation of ensuring that any and all shooting activities are safe for everyone. This requires your personal commitment to carefully read, fully understand, and exercise the principles of proper firearm safety at all times.

## DISCLAIMER

THE FIREARM IN WHICH THESE SAFETY RULES APPLY IS SOLD UNDER THE EXPRESSED CONDITIONS THAT THE MANUFACTURER ACCEPTS NO LIABILITY IN PART OR WHOLE FOR BODILY INJURY, DEATH, OR PROPERTY DAMAGE FROM:

- IMPROPERLY OR CARELESSLY HANDLING THE FIREARM.
- USING DEFECTIVE, IMPROPER CALIBER, HAND-LOADED, NON STANDARD OR RELOADED AMMUNITION.
- INADEQUATE MAINTENANCE OF THE SHOTGUN RESULTING IN CORROSION OR DAMAGE, NEGLIGENCE OF MALFUNCTIONS.

- 
- RESALE IN CONTRADICTION OF ANY APPLICABLE LAWS OR REGULATIONS,
  - ALTERING OR CONVERTING THE FIREARM'S ORIGINAL AESTHETIC, FUNCTIONING MECHANISMS, ACCESSORIES, OR MECHANICAL CONFIGURATION,
  - DISCHARGING WITH CRIMINAL INTENT OR NEGLIGENCE.
  - FAILURE TO UNDERSTAND, ADHERE TO, AND FOLLOW THE RULES OF FIREARM SAFETY WHEN USING OR HANDLING THE FIREARM.
  - OR ANY OTHER CIRCUMSTANCES OUTSIDE THE MANUFACTURER'S DIRECT OR IMMEDIATE CONTROL.

## **FIREARM SAFETY**

**IMPORTANT WARNING:** IT IS IMPORTANT FOR YOU TO RECEIVE PROPER TRAINING FROM A COMPETENT FIREARMS INSTRUCTOR OR AUTHORITY BEFORE BEGINNING TO SHOOT OR WHEN HANDLING THE FIREARM.

**IMPORTANT WARNING:** FAILURE TO ADHERE TO THE RULES OF FIREARM SAFETY CAN RESULT IN SERIOUS INJURY, DEATH, OR DESTRUCTION OF PROPERTY

**1) COMPLETELY READ AND UNDERSTAND YOUR OWNER'S MANUAL GUIDELINES BEFORE USING YOUR FIREARM.** You should fully understand the function of all of the components and mechanics of the firearm. Before you remove the firearm out of the box thoroughly read the owner's manual on how to properly carry, handle, load, unload, and store your new firearm. Know the rules of proper gun safety and exercise them at all times because failure to do so may result in death or injury to yourself or others. Because it is impossible to list every firearm situation or scenario, be aware that certain circumstances may require additional safety rules unique to a particular situation. In these cases, we recommend that you use

---

**2) ALWAYS LEARN THE SPECIFIC MECHANICAL AND HANDLING CHARACTERISTICS OF YOUR SHOTGUN.** All firearms are different thus it is important for you to understand how to properly carry, use, and handle each one according to its specific guidelines. Before using any firearm, one must completely familiarize themselves with the type of firearm and its specific safe handling procedures for loading, unloading, carrying,

**NEVER**

- Give the shotgun to any person who has not thoroughly familiarized himself or herself with all of the information, safety rules, and warnings in the owner's manual.

**3) ALWAYS KEEP THE FIREARM UNLOADED UNTIL READY TO USE.** Firearms should be kept unloaded when not in use. Whenever you pick up a firearm, immediately engage the safety device and remove the magazine to visually inspect the chamber and confirm that it is clear. Always unload all ammunition from the chamber and remove the magazine after: 1) shooting, 2) before putting the firearm away, 3) putting it into a holster, 4) when not in use, and 5) when handing it over to another person.

**NEVER**

- Leave a loaded gun unattended, propped up against a surface, or out of your hands.
- Assume a firearm is unloaded, even if you used it last. Always check to make sure that there is no ammunition and the chamber is clear.
- Load a cartridge into the chamber until you are ready to fire.
- Carry or transport your firearm with live ammunition in the chamber.
- Pass a firearm to another person or accept a firearm from another person, until the cylinder or action is open and you have personally checked that the weapon is completely unloaded.
- Haul a loaded firearm openly or in a carrying case.
- Never transfer or hand a loaded firearm to someone else.

---

**4) ALWAYS KEEP YOUR FINGER OFF THE TRIGGER UNTIL YOU ARE READY TO SHOOT.** When holding the firearm be sure to rest your finger on the trigger guard and along the side of the gun.

**NEVER**

- Touch the trigger until you are ready to fire.
- Engage in horseplay while handling a firearm.
- Rely on the safety devices of the gun. Mechanical safeties are never foolproof and can wear out and malfunction overtime. Remember to always handle all firearms using proper gun safety guidelines.

**5) ALWAYS KEEP THE GUN POINTED IN A SAFE DIRECTION.** A safe direction is one in which an accidental discharge cannot or would not cause injury or harm to yourself or others. Use extreme caution especially when loading and unloading your firearm. When handling any firearm always treat it as if it was loaded and ready to fire, even if you think it is empty. The recommended carrying position of your shotgun is with the hammer in de-cocked position.

**NEVER**

- Point your firearm at anything you don't intend to shoot.
- Use a firearm under the influence of alcohol, drugs, or any other substances that may impair your judgment, skills, or physical abilities.
- Target shoot or hunt with a firearm when you are fatigued or too tired to operate the firearm safely.
- Use your firearm if you have an illness or disability that could compromise your judgment and the safety of yourself or others.

**6) ALWAYS USE THE CORRECT AMMUNITION.** All firearms are manufactured to use a certain caliber or gauge of ammunition. Only use ammunition that the manufacturer has recommended. Always verify before loading that you have the correct ammunition that matches the manufacturer's recommendations. Using improperly reloaded or incorrect ammunition can cause death and injury. This can also damage or destroy your firearm which will void any warranty.

---

## NEVER

- Shoot the gun unless you know you have the proper ammunition.
- Use hand loaded, non-standard or reloaded ammunition.
- Fire ammunition that exceeds industry standard pressure specifications.
- Use old, soiled, or damaged ammunition.
- Use ammunition which does not feed reliably in your particular firearm as it may malfunction at a critical juncture.

## 7) ALWAYS STORE YOUR FIREARM IN A SECURED STORAGE AREA TO PREVENT UNAUTHORIZED ACCESS OR USE FROM OTHER INDIVIDUALS.

There are many types of firearm storage devices as well as locking devices that attach directly to the firearm itself. Each individual must consider their particular circumstances so that the firearm is stored and maintained for optimal safety and security. Metal gun safes are recommended over open racks or glass front cabinets. Mechanical safeties built into the firearm can fail and should not be used as a substitute for safe gun handling and adherence to all firearm safety rules. Additionally, always store your ammunition locked up and secured separately from any firearms.

## NEVER

- Store or hide a loaded firearm
- Leave your firearms where unauthorized access from other individuals can occur.
- Allow access to individuals who do not understand or follow the rules of proper gun safety
- Leave a unsecured firearm in a bed, drawer, closet, or any other vehicle that could allow access to children or other unauthorized individuals
- Allow children under the age of 18 access to any firearms without close supervision and proper firearm safety training.

---

**8) ALWAYS COMPLY WITH ALL LOCAL, STATE, AND FEDERAL LAWS THAT GOVERN THE OWNERSHIP, STORAGE, CARRYING, AND USE OF FIREARMS.**

- 

**9) ALWAYS KNOW YOUR TARGET AND WHAT IS BEYOND.** Before you pull the trigger be sure of your target and what is behind it. Shoot only in areas that have approved backdrops such as a shooting range, or backstops such as a hillside or berm. Also, know how far your shot will travel in case you miss the target or the bullet ricochets.

- 

**10) ALWAYS WEAR EYE/ EAR/BODY PROTECTION.** Gases and debris can cause injury so it is very important that one wears protective gear to preserve their hearing and eyesight. Also, while in the field wear at least 1000 square inches or more of blaze orange so that you can be visible by others.

**NEVER**

- Discharge a firearm in a poorly ventilated area.



---

**IMPORTANT WARNING:** POSSIBLE LEAD EXPOSURE CAN OCCUR WHEN DISCHARGING FIREARMS IN A POORLY VENTILATED AREA, CLEANING THE FIREARM, OR HANDLING AMMUNITION. LEAD AND ITS COMPONENTS IS A SUBSTANCE KNOWN TO CAUSE BIRTH DEFECTS, REPRODUCTIVE DESTRUCTION/IMPAIRMENT, CANCER, OR OTHER SERIOUS HEALTH CONDITIONS AND INJURY. ALWAYS HAVE ADEQUATE VENTILATION AT ALL TIMES AND WASH YOUR HANDS AND OTHER CONTACT AREAS THOROUGHLY AFTER EACH EXPOSURE.

**11) ALWAYS HANDLE WITH EXTREME CARE IF YOUR GUN FAILS TO FIRE WHEN THE TRIGGER IS PULLED.**

If the ammunition doesn't fire when you pull the trigger, STOP! and remember to always keep the firearm pointed in a safe direction. Keep your face away from the breech, then put the safety on, carefully open the action, unload the firearm and dispose of the cartridge safely. Always keep in mind that anytime there is a shell in the chamber, your firearm is LOADED and ready to fire. Even if you tried to shoot and the firearm did not fire, always treat it as if it could still discharge.

**12) ALWAYS TREAT THE FIREARM AS IF IT WAS LOADED, EVEN IF THE SAFETY IS POSITIONED CORRECTLY AND KEEP YOUR FINGERS AWAY FROM THE TRIGGER WHEN LOADING AND UNLOADING.**

A gun is a mechanical device and is not foolproof and is subject to wear and tear over time. Always keep your fingers away from the trigger when you are loading and unloading. If the manual safety proves to be ineffective for any reason, danger of an unintentional discharge exists, the weapon is then must be immediately unloaded and restricted from further use. Contact [www.winmarkshotguns.com.tr](http://www.winmarkshotguns.com.tr) so that the gun can be inspected and repaired by an authorized gunsmith. **REMEMBER..THAT ANY FIREARM SAFETY MECHANISMS CAN FAIL, EVEN IF THE SAFETY IS ENGAGED. YOU SHOULD ALWAYS ASSUME THAT A FIREARM IS LOADED WHEN HANDLING IT.**

**13) ALWAYS KEEP YOUR SHOTGUN IN THE SAME MECHANICAL AND STRUCTURAL CONFIGURATION AS IT WAS WHEN IT WAS MANUFACTURED.** This shotgun was produced under specific manufacturer guidelines and should not be altered or changed under ANY circumstances. Performing conversions by altering the trigger, mechanical components, safety mechanisms, or using any other products other those provided in the original box is **NOT RECOMMENDED** by the manufacturer, and could result death, bodily harm, or compromising your safety or the safety of others. Any alteration made to the firearm also voids the factory warranty.

---

Like any mechanical device it is subject to normal wear and tear from use. In order to maintain optimal safety and performance it should be periodically serviced. You must regularly clean and lubricate your firearm to maintain its functionality, accuracy, safety, and reliability. Always before cleaning or lubricating any firearm make sure that you perform a safety check to make sure that the firearm is completely unloaded prior to performing any routine maintenance. If for some reason your firearm does require repairing, please visit [www.winmarkshotguns.com.tr](http://www.winmarkshotguns.com.tr) for contact information in regard to parts and repair services for your WINMARK shotgun.

### **NEVER**

- Alter, convert, or change your firearm from its original manufacturer's configuration.

**IMPORTANT WARNING:** THIS FIREARM WAS DESIGNED TO FUNCTION PROPERLY IN ITS ORIGINAL CONDITION. THE MANUFACTURER WILL NOT BE HELD LIABLE OR LEGALLY RESPONSIBLE FOR ANY ALTERATION PERFORMED ON THE FIREARM AFTER IT LEAVES THEIR CONTROL. THIS INCLUDES ANY ADDITION OR SUBSTITUTION OF PARTS OR ACCESSORIES THAT ARE NOT MANUFACTURED BY WINMARK SAVUNMA TARIM LTD. ANY CHANGES MADE TO THE FIREARM IS SPECIFICALLY CONTRARY TO OUR INSTRUCTIONS AND WE EXPRESSLY DO NOT AUTHORIZE ANY CHANGES BE MADE AFTER MANUFACTURE. DO NOT JEOPARDIZE THE SAFETY OF YOURSELF OR OTHERS BY MAKING MODIFICATIONS TO YOUR FIREARM.

**14) ALWAYS MAKE SURE THE BARREL IS CLEAR OF ANY OBSTRUCTIONS BEFORE SHOOTING.** Before loading always perform a safety check to make sure that there is no ammunition in the chamber or magazine. Examine the barrel for any obstructions or debris such as excess lubricant, dirt, or grease. If the bore is obstructed it can cause increased pressure causing the barrel to bulge or burst during use. Always use a cleaning rod and patch to remove any residues or obstructions in the barrel. Be familiar with your firearm. If the noise or recoil seems muffled or weak then STOP! And proceed to unload your firearm and check to make sure nothing is lodged in the barrel.

### **NEVER**

- Try to shoot out an obstruction by loading another shell and firing.

---

### **SERIAL NUMBER OF THE FIREARM**

The serial number is located on various parts of the shotgun. Each serial number is specific to that shotgun and is used for identification and registration. It is recommended that you record your serial number in your manual and keep the information in a secured location.

### **MANUFACTURER'S RECOMMENDATIONS FOR INITIAL USE**

As with all gas-operated shotguns, a short "break-in" period of a box or two shells for reliable operation is required. It is recommended that loads of 1oz - 1<sup>1/8</sup> oz and 1250fps to 1350 fps be used with the low-velocity piston that comes pre-installed in the gun for the "break-in" period. At any point, do not use loads above the above-listed weight or velocity without installing the HV marked piston first.

### **IMPORTANT CONSIDERATIONS FOR SELECTING AMMUNITION**

Shotgun ammunition has an extremely wide range of projectile styles, weights, and velocities. Gas-operated shotguns are only intended to run on STANDARD weight and velocity ammunition. Most ammunition labeled "low recoil" does not have enough pressure to operate semi-auto shotguns. There are also many styles of ammunition that are beyond the factory recommendations for weight or velocity. 1.5 oz maximum or 1500 feet per second is the maximum safe limit.

### **AMMUNITION RECOMMENDATIONS AND GUIDELINES**

Your panzer arms shotgun is designed to give you a lifetime of use with standard loads from 1oz to 1.5oz and 1250 feet per second to 1500 feet per second maximum. Shooting ammunition that is above the maximum weight or above the maximum velocity will cause damage, void your warranty, and could cause personal injury. It is your responsibility to understand what ammunition is and is not acceptable to use in your WINMARK shotgun.

---

### **LOADING THE SHOTGUN**

- 1) First, point the shotgun in a safe direction. Remember, a safe direction means that the gun is pointed so that even if it were to go off, it would not cause injury, damage, or death. Always perform a safety check to make sure that the chamber is empty.
- 2) When the magazine is empty, the bolt catch lever holds the bolt open at the rear. Press the magazine release to remove the empty magazine and insert a loaded magazine. Remember to only use ammunition that is recommended by the manufacturer.
- 3) Push down the bolt catch lever with the thumb of the shooting hand and this will allow the bolt to move forward and chamber a round.

### **THE SHOTGUN IS NOW LOADED AND READY TO FIRE!**

**IMPORTANT WARNING:** ALWAYS UNLOAD YOUR FIREARM IMMEDIATELY AFTER SHOOTING

### **RECOMMENDATIONS FOR CLEANING DURING USE**

During use of your firearm, it may be necessary to clean the gas system from every 100-400 rounds depending on how much residue is deposited. It is recommended that during this time that the parts and fasteners of the firearm including barrel nut are checked to make sure they have not become loose.

### IMPORTANT WARNING

It is your responsibility to check for clearance and proper operation by manually cycling your action after ensuring that the firearm is unloaded when attaching any accessories or aftermarket products to your Armelegant shotgun.

### IMPORTANT INSTRUCTIONS FOR HIGH VELOCITY/WEIGHT AMMUNITION

Your Armelegant shotgun comes with its "low velocity" piston pre-installed. To run ammunition at or above either 1<sup>1/4</sup> oz or 1350 feet per second, you must first install the piston marked HV to prevent excessive recoil, internal wear, and possible damage.

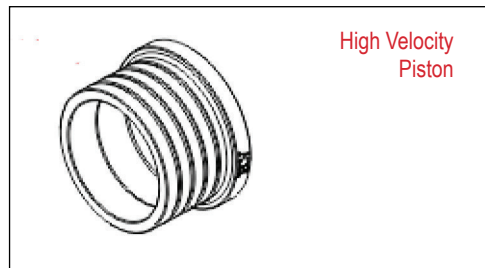
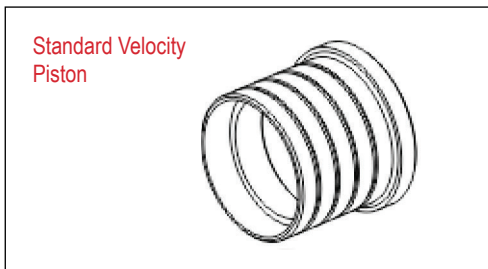

### IMPORTANT INSTRUCTIONS FOR CHOKES

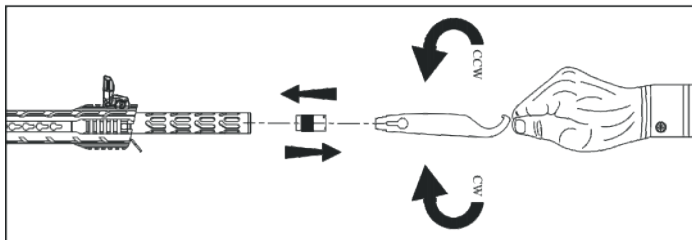

1) You must ensure that the choke is hand tight before firing.

**WARNING:** Do not use anything other than the #5 (skeet/cylinder) choke for slugs. Do not shoot slugs that are heavier/faster than 1 oz or 1500 fps. Sabot slugs are not designed for use in smooth barrel shotguns.

---

## IMPORTANT INSTRUCTIONS FOR FEED RAMP

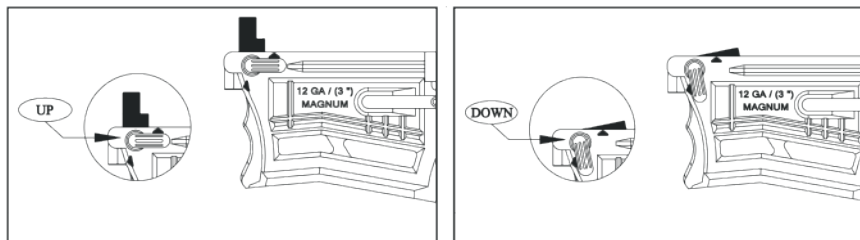

**WARNING :** FEED RAMP GUIDES THE CARTRIDGE FROM MAGAZINE TO THE CHAMBER. BEFORE INSERTING MAGAZINE INTO THE WELL, THE FEED RAMP MUST BE TURNED UP OTHERWISE THE MAGAZINE CANNOT BE SEATED INTO THE WELL. TO TURN UP THE FEED RAMP; PULL CHARGING HANDLE FOR ABOUT AN INCH, THEN TURN THE FEED RAMP LEVER UPWARD DIRECTION.

**CAUTION :** BEFORE STRIPPING MOVING PARTS (BOLT, BOLT CARRIER, BOLT HANDLE); POSITION OF THE FEED RAMP LEVER MUST BE TURNED DOWNWARD DIRECTION. OTHERWISE IT BLOCKS THE RECEIVER AND APPLIES PRESSURE TO THE BOLT WHICH MAY LEAD TO THE FEED RAMP TO BREAK OR BEND.

## DIAGRAM VIEW

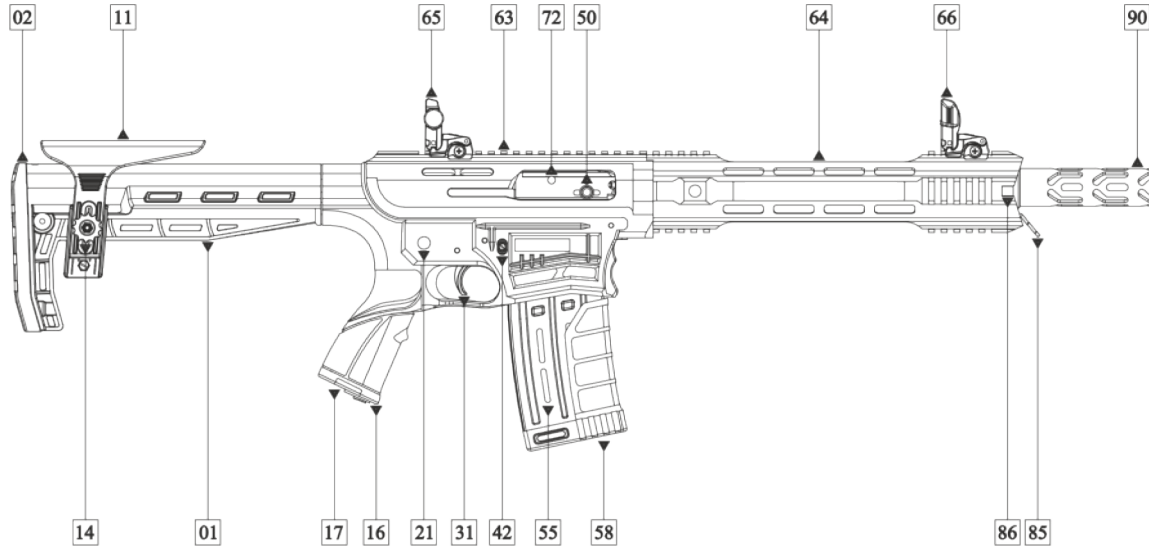

02	Recoil Pad	50	Charging Handle	86	Handguard Retainer	21	Safety
11	Cheek Piece	64	Handguard	58	Magazine Floor Plate	16	Pistol Grip
65	Line of Sight	66	Front Sight	55	Magazine	17	Pistol Grip bottom
63	Upper Receiver	90	Muzzle Brake	42	Magazine Release Button	01	Lower Receiver
72	Bolt	85	Front swivel	31	Trigger	14	Height Adjustment

## EXPLODED VIEW

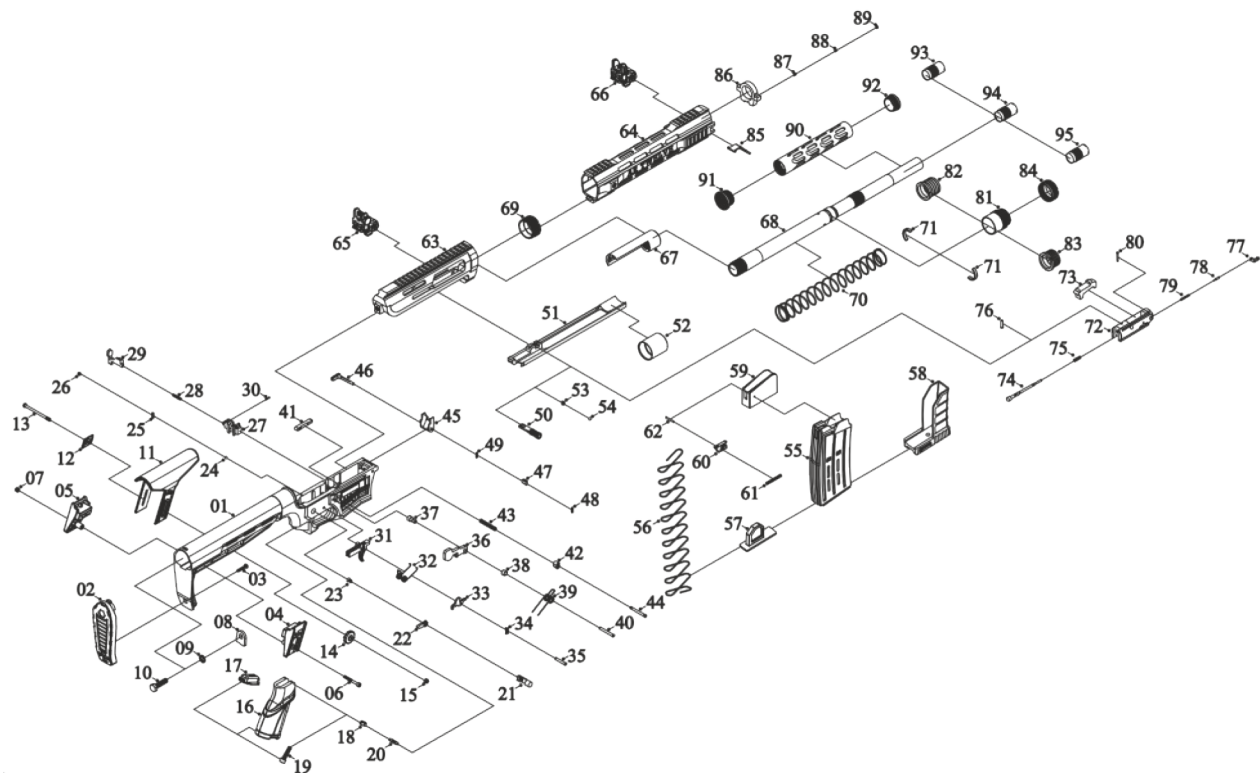



## PART LIST

1	Lower Receiver	33	Disconnecter	65	Line of Sight
2	Recoil Pad	34	Disconnecter Spring	66	Front Sight
3	Recoil Pad Screw	35	Trigger pin	67	Barrel Extension
4	Cheek Piece right retaining plate	36	Hammer	68	Barrel
5	Cheek Piece left retaining plate	37	Hammer Spring Outer Bushing	69	Barrel nut
6	Right retaining plate screw (cheek piece)	38	Hammer Spring Inner Bushing	70	Operation spring
7	Left retaining plate screw (cheek piece)	39	Hammer Spring	71	Gas System Retainer Ring
8	Butt Stock Fixing Plate	40	Hammer Pin	72	Bolt
9	Butt Stock Fixing Washer	41	Magazine Release	73	Locking Block
10	Butt Stock Fixing Screw	42	Magazine Release Button	74	Firing Pin
11	Cheek Piece	43	Magazine Catch Spring	75	Firing pin spring
12	Cheek Piece Setting Plug Nut	44	Magazine Release Screw	76	Firing pin retaining pin
13	Cheek piece retaining screw	45	Feed Ramp	77	Extractor
14	Height Adjustment nut	46	Feed Ramp Lever	78	Extractor pin
15	Cheek piece retaining nut	47	Feed Ramp Retainer	79	Extractor pin spring
16	Pistol Grip	48	Right Retainer Spring (Feed Ramp)	80	Extractor Retaining Pin
17	Pistol Grip bottom cover	49	Left Retainer Spring (Feed Ramp)	81	Gas Block
18	Pistol Grip Assembly Nut	50	Charging Handle	82	Standard Velocity Piston
19	Pistol Grip Screw	51	Bolt Carrier	83	High Velocity Piston
20	Pistol Grip Washer	52	Bolt Carrier Tube	84	Gas Cylinder Locking Ring
21	Safety	53	Charging Handle ball bearing spring	85	Front swivel
22	Safety Selector	54	Charging Handle Ball Bearing	86	Handguard Retainer
23	Safety Selector Screw	55	Magazine	87	Handguard Retainer Spring
24	Safety Ball Bearing	56	Magazine Spring	88	Hand Guard Retainer Pin
25	Safety Spring	57	Magazine Spring Stand	89	Hand Guard Retainer Screw
26	Safety Spring Screw	58	Magazine Floor Plate	90	Muzzle Brake
27	Bolt Catch Body	59	Magazine Follower	91	Muzzle Brake Rear nut
28	Bolt Catch Spring	60	Last Round Hold Open Tab	92	Muzzle Brake Front nut
29	Bolt Catch Button	61	Retention Spring	93	Full Choke I
30	Bolt Catch Pin	62	Roll Pin	94	Modified Choke I I I
31	Trigger	63	Upper Receiver	95	Skeet/Cylinder Choke I I I I I
32	Trigger Spring	64	Handguard		

---

## SHOTGUN DISASSEMBLY INSTRUCTIONS

**MANUFACTURERS WARNING:** THIS MANUFACTURED FIREARM WAS DESIGNED TO PERFORM WITH ITS ORIGINAL PARTS. IT IS YOUR RESPONSIBILITY TO MAKE SURE THAT ANY PARTS YOU BUY ARE AUTHENTIC AND CORRECTLY INSTALLED AND THAT THE PARTS HAVE NOT BEEN ALTERED OR CHANGED. IT IS IMPERATIVE THAT ONLY FACTORY PARTS BE USED AS REPLACEMENTS TO ASSURE THAT THE FIREARM REMAINS FUNCTIONALLY SAFE AND OPERATES ACCURATELY. THE GUN OWNER ACCEPTS FULL RESPONSIBILITY FOR THE CORRECT REASSEMBLY AND FUNCTIONING OF THE FIREARM AFTER ANY DISASSEMBLY OR REPLACEMENT OF PARTS.

**IMPORTANT WARNING:** BEFORE YOU BEGIN ANY DISASSEMBLY ALWAYS 1) POINT THE SHOTGUN IN A SAFE DIRECTION 2) BE SURE THAT YOU REMOVE THE MAGAZINE FROM THE FIREARM 3) VISUALLY AND MANUALLY INSPECT THE CHAMBER TO CONFIRM THAT IT IS EMPTY.

### IMPORTANT WARNING!

**WARNING :** Before you disassemble or clean your firearm, it is your responsibility to check that it is unloaded in a safe manner.

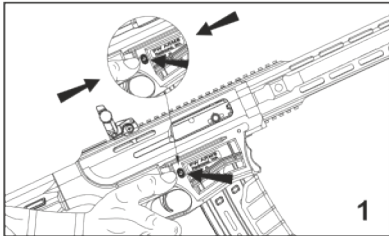

1. Press the latch, remove the magazine.

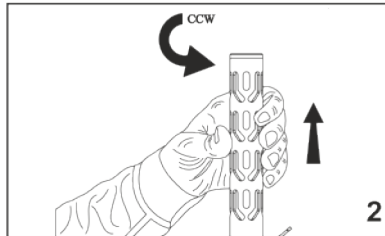

2. Remove the barrel shroud in the direction indicated, then the handguard retainer.

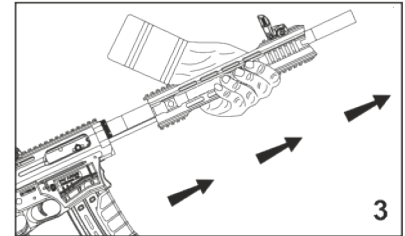

3. Remove the handguard.

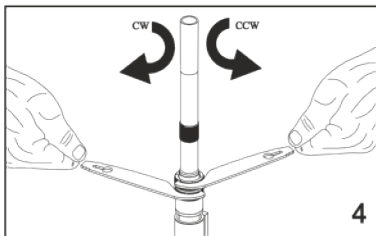

4. To remove the gas system. Hold the gas cylinder stationary with one wrench while turning the gas chamber lock nut in the direction indicated.

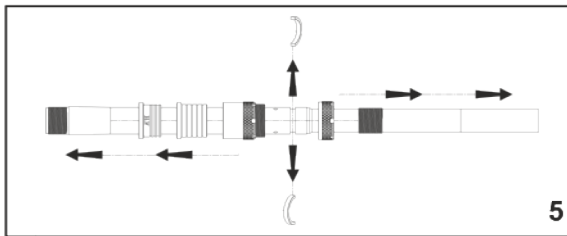

5. Push the gas cylinder towards the receiver to expose the gas system retaining rings. Then, pull the gas cylinder and gas piston down the length of the barrel

**Please note:**

You may find it helpful to clean deposits near the gas ports on the barrel before gas cylinder or piston removal.

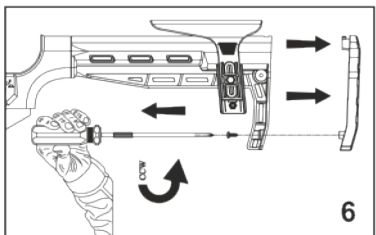

6. To remove the upper receiver from the lower receiver, you must start by removing the butt pad to gain

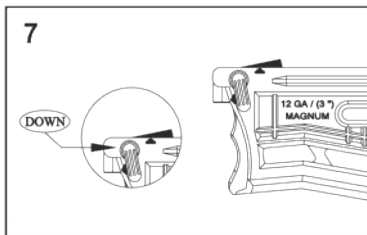

7. Once the butt pad is removed you must lower the feed ramp before attempting to remove the

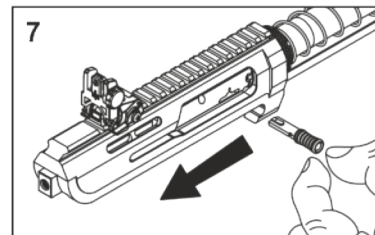

7. To lower the feed ramp you must hold the charging handle back while rotating the feed ramp lever to the downward

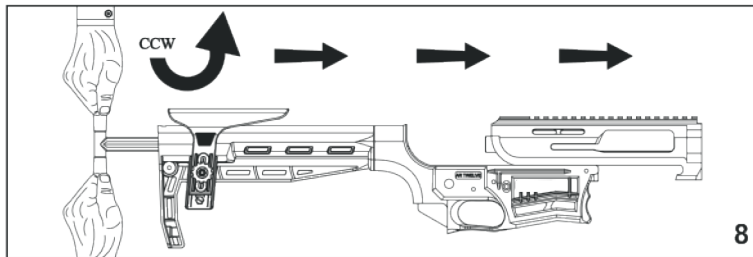

8. After removal of the butt stock bolt, you are now able to separate the upper receiver assembly from the lower receiver.

**Attention: Please note, this is the LAST step of in the typical disassembly procedure.**

#### **IMPORTANT WARNING**

**PLEASE NOTE:** BARREL NUT REMOVAL IS NOT A PART OF THE TYPICAL CLEANING OR DISASSEMBLY PROCESS. IT IS NOT RECOMMENDED FOR TYPICAL DISASSEMBLY OR CLEANING AS THE **BARREL NUT TORQUE IS CRITICAL AND MUST BE SET BY AN AUTHORIZED REPAIR FACILITY.**

**IMPORTANT WARNING:** BEFORE YOU START CLEANING YOUR SHOTGUN ALWAYS MAKE SURE IT IS UNLOADED AND POINTED IN A SAFE DIRECTION.

**LUBRICATION WARNING:** FIRING A SHOTGUN WITH OIL, GREASE, OR OTHER DEBRIS PARTIALLY OBSTRUCTING THE BORE MAY RESULT IN DAMAGE TO THE FIREARM OR INJURY TO THE SHOOTER AND THOSE NEARBY BEFORE FIRING MAKE SURE THE BORE AND CHAMBER OF THE BARREL IS UNOBSTRUCTED AND DRY NEVER SPRAY OR APPLY LUBRICANT ON SHOTSHELLS. FIRING ANOTHER SHOTSHELL BEHIND AN OBSTRUCTION MAY DAMAGE THE SHOTGUN AND CAUSE DEATH OR INJURY. ONLY USE LUBRICANTS PROPERLY AND SPARINGLY. YOU ARE RESPONSIBLE FOR THE PROPER CARE AND MAINTENANCE OF YOUR SHOTGUN.

---

STEP 1) DISASSEMBLE YOUR SHOTGUN.

STEP 2) USING A PROPER CLEANING ROD, RUN A SOLVENT-WETTED PATCH THROUGH THE BORE SEVERAL TIMES. THIS WILL THEN BE FOLLOWED BY RUNNING DRY PATCHES THROUGH THE BORE TO REMOVE ANY DEBRIS OR RESIDUE.

STEP 3) IF THE BORE IS LEADED TO THE EXTENT THAT THE ABOVE PATCH CLEANING PROCEDURE DID NOT REMOVE THE LEAD, THEN SCRUB THE BORE FULL LENGTH WITH A SOLVENT-WETTED BRASS BRISTLE BRUSH. WHEN THE LEADING IS LOOSE THEN REPEAT STEP #2.

STEP 4) THE SURFACES OF BOLT CARRIER, EJECTOR, AND INSIDE SURFACES OF THE RECEIVER SHOULD BE COATED VERY LIGHTLY WITH NON-PENETRATING LUBRICATING OIL.

STEP 5) REASSEMBLE THE SHOTGUN AND WIPE THE EXTERIOR METAL SURFACES SPARINGLY WITH AN OILED CLOTH. SWAB THE BORE WITH AN OILY PATCH BEFORE STORING THE FIREARM.

STEP 6) PLACE THE SHOTGUN IN A SAFE, LOCKED STORAGE SPACE WHERE UNAUTHORIZED PERSONS CANNOT ACCESS THE FIREARM. NEVER STORE THE SHOTGUN IN A LEATHER CASE AS LEATHER ATTRACTS

### **WARRANTY**

[www.winmarkshotguns.com.tr](http://www.winmarkshotguns.com.tr)

The manufacturer provides to the original retail purchaser a LIMITED WARRANTY for a period of six (6) year from the date of purchase against defects in material or workmanship. It will be the discretion of the manufacturer and importer as to whether the parts/labor or replacement will result in a charge to the consumer. The importer or manufacturer has the right to research, inspect, and test the weapon to assess any claim made under the warranty.

### **WARRANTY EXCLUSIONS**

The warranty is VOID if the firearm has been altered, abused, misused, damaged by accident, fired with hand loaded or reloaded ammunition, obstructions in the barrel, or damage due to failure to provide regular and necessary maintenance. Also this warranty is VOID if any unauthorized repair or alteration is performed on the firearm.

---

## NOTES

A series of 18 horizontal dotted lines for taking notes.



[www.winmarkshotguns.com.tr](http://www.winmarkshotguns.com.tr)

KONYA / TURKEY

+90 542 332 66 62

[info@winmarkshotguns.com.tr](mailto:info@winmarkshotguns.com.tr)